

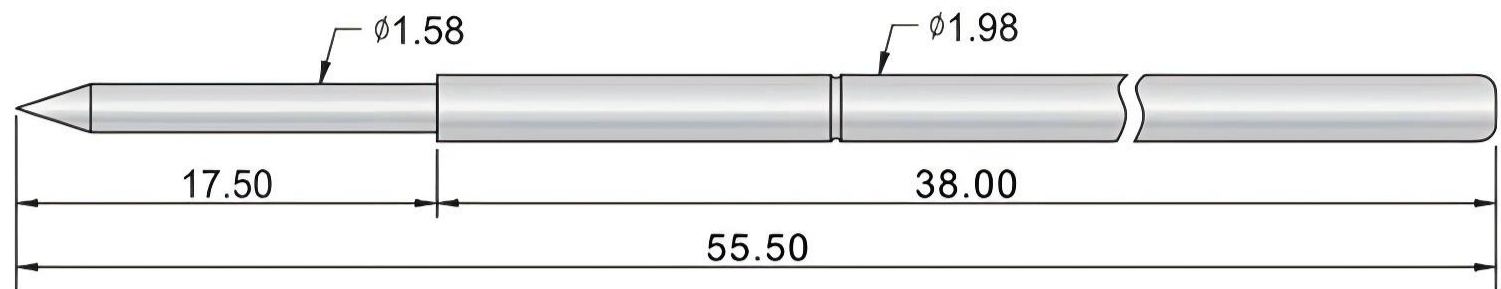

1353L

1353L-B

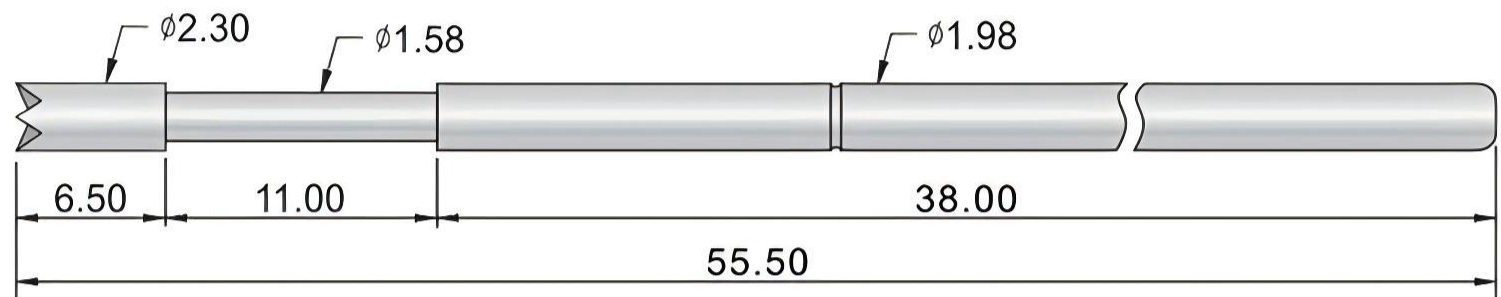

1353L-Q

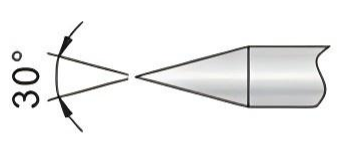

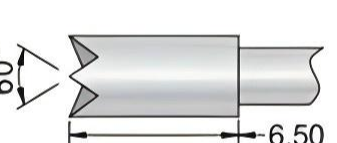
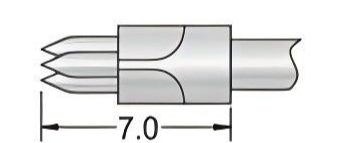
| | | | |
|---|----------|---|-------------------------------|
|  | 1353L-B | 技术要求 (Technical Specifications) : | |
| | | 额定电流 (Current Rating) | 3A |
| | | 接触电阻 (Contact Resistance) | 50 milliohm |
| | | 行程弹力 (Spring Force at Stroke) | 380g |
|  | 1353L-H | 材质 (Materials) : | |
| | | 针杆 (Plunger) | BeCu or SK4,Rh or gold-plated |
| | | 针管 (Barrel) | Ph,gold-plated |
| | | 弹簧 (Spring) | Music Wire |
|  | 1353L-Q | 成品型号 (Product Type) : | |
|  | 1353L-M3 | <p>1353L-Q-380g</p> <p>系列 型号 头型 弹力</p> <p>订购举例:1353L-Q-380g</p> | |

RL1353-W

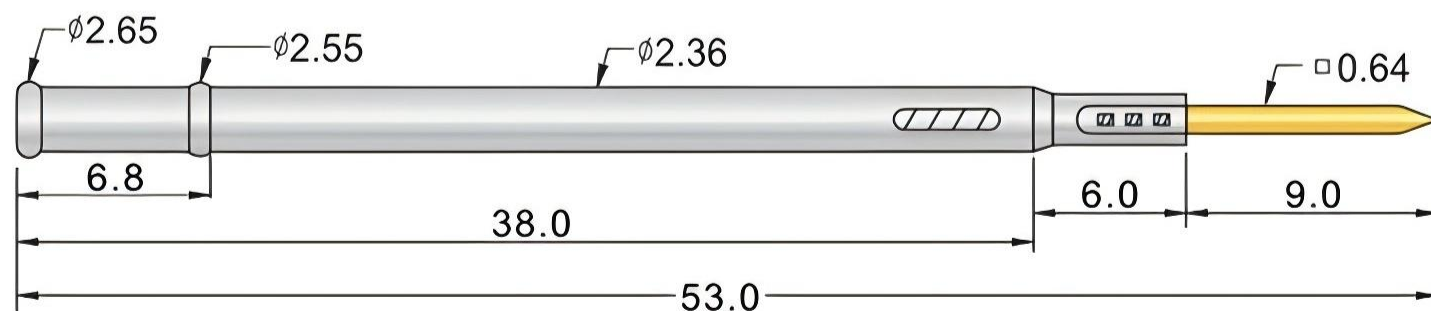

钻孔尺寸 : 2.40mm

| | | |
|--|--------------------|-------------------|
| 成品型号 (Product Type) : | 材质 (Materials) : | |
| <p>RL1353-W</p> <p>系列 规格 尾部特征</p> <p>订购举例:RL1353-W</p> | 针套(Receptacle) | Brass,gold-plated |

PROBE



PEXON

E-mail: sale@pinconnector.com

WhatsApp: +86-13361867201

www.pinconnector.com